

SPON

NETWORK AUDIO TERMINAL
User Manual

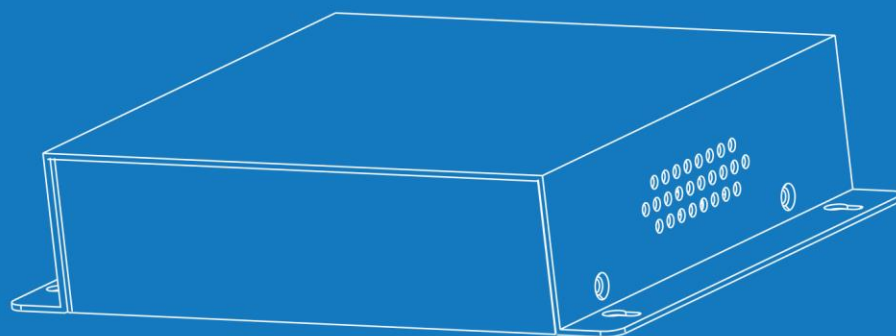

Contents

Summarize	1
Safety precaution.....	1
Product Introduction	2
Hardware Interface description	2
Introduction	3
Packing list	3
Wiring.....	4
Basic Network Setting	5
User-define terminal parameters	5
Login Web Interface	5
Network Parameters.....	6
The wireless channel setting (2.4G wireless module is available).....	7
Language setting	7
Audio parameters	8
Audio auto-detect function	8
Wireless amplification sampling rate (2.4G wireless module is available)	8
Password Setting.....	8
Reboot Device	9
Reset to defaults	9
Update Firmware (Note: It shouldn't update unless there is a special requirements)	9
Basic Function	10
Offline broadcasting.....	10
Real-time broadcasting	10
Receive terminal broadcasting, server task	10
Fault Exclude	10
Copyright Announcement	11

Summarize

Safety precaution

Please abide by the warning and the relevant safety tips.

Please take this manual in convenient place after you reading the guide for future reference.

Warning



The sign means there is potential safety hazard, when operate wrong may result in death or serious injury.



The sign is used to remind the user that attached is the important operation and maintenance data.

Setting and Installation

(1) Avoid being wet with the water.

Don't make the machine or exposed to rain water or other liquid contamination of the environment, or lead to fire or get an electric shock.

(2) Don't use unspecified voltage.

Using the marked voltage on the machine.

Using more than the logo of voltage could lead to fire or shock.

(3) Don't scratch the power cord.

Don't scratch the power cord or cut it.

Simultaneous, keep the power line far way from heated objects, put heavy things on it will lead to fires or electric shock.

Using machine

(1) In case of the anomalies

Please turn off the power supply immediately when finding the abnormal phenomena, please connect with the agency.if you continue to use, it will likely fires or shock.

- The smoke or odor of the machine.
- The inside of the machine is flooded by water or foreign bodies intrusion.
- Machine falling or machine shell damage.
- The power cord damage(wire core is exposed of broken, etc)
- Fault(eg: it can't network, no sound ..etc)

(2) Don't open the machine internal or modify the machine

Do not let foreign matters invade the machines internal.

Don't let the metal items or inflammable objects inserting machine such as foreign inserting machines or throw into the vents machines internal, otherwise will likely cause fires or electric shock.

(3) Please do not touch it when thundering

To avoid electric shock, please do not touch the machine and the plug when lightning, etc.

(4) Please do not place containers with liquid or small metal objects on machine above

If gets upset containers, and let the fluid inflow to the machine that will likely fires or cause shock.

(5) Do not open the machine internal or modify the machine

The machine internal contains high voltage parts, once open the cover or modify the machine, it will likely fires or cause shock.

All the maintenance and other machine modification should be operated by professional personnel.

(6) Maintenance and the precautions for not using in a long time

While maintenance, if the machine is not using for 10 days or more , please shut off power supply switch for safety. If do not comply with this provision, it will likely cause electric shock or fires.

Product Introduction

Network audio terminal built-in independent intellectual property rights IP Audio digital network technology. It's equipped with power input interface, alarm input, audio input/ output port , network input interface, alarm input/output interface.



- Adopt high speed industrial grade dual-core chip, starting time ≤1 second.
- MP3、WAV audio decode.
- 1 analog audio input/output interface.
- Support 2.4G wireless module work with 2.4G wireless microphone (optional)
- Offer 2*10W and 2*30W power for selection.
- Standard RJ45 network interface,it can access any Ethernet, support across the network segment and route.

Hardware Interface description

Side

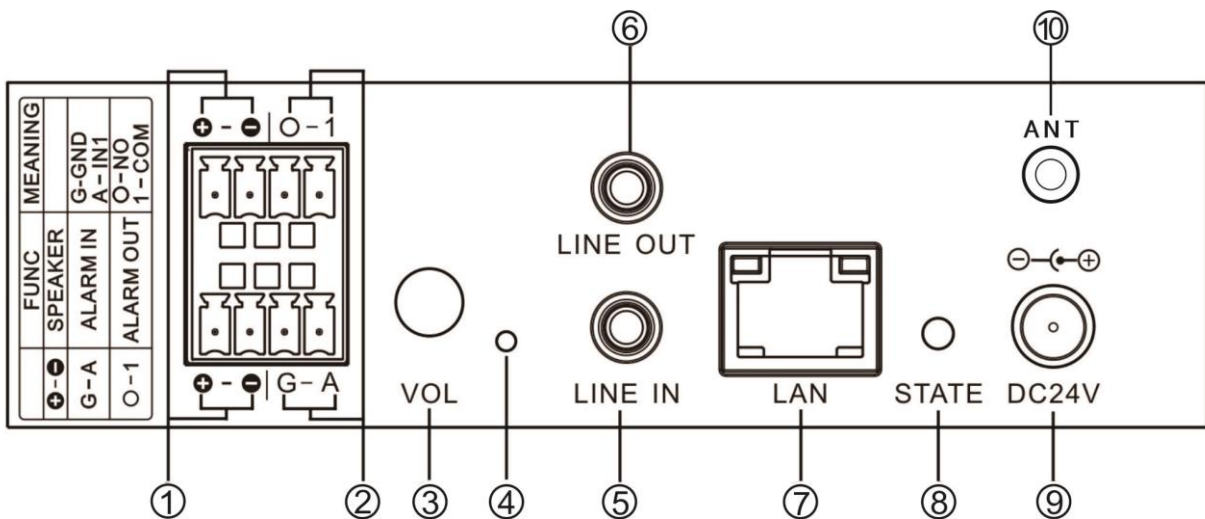

①Amplifier output interface: Internal power amplifier output port, it offer two way power amplifier output, it can output from amplifier when the terminal is receiving broadcasting or playing the background music. When the terminal power is 20W, amplifier output 2*10W; when the power is 60W, amplifier output 2*30W.

②Alarm input/output interface: G-A: alarm input interface, O-1: alarm output interface.

③The volume adjustment knob: used for line input volume adjustment, clockwise for up, anticlockwise for down.

④Forced upgrade or play device IP button

When the terminal without power on, press ④button by tweezers or pin, then power on till 5 seconds, so that it will enter into upgrade status (press this button can voice play the terminal IP and subnet mask information in free status).

⑤Line input interface: it can connect the external analog sound source (eg: dynamic microphone, computer...etc) to this port.

⑥Line output interface: this port output the restored audio signal; It can used as a sound source access to the active speakers, audio pre-amplifier, sound console, audio amplifier device...etc.

⑦ Network interface: this port connect with Ethernet by cables.

⑧ STATE: status light

If the terminal is upgrading firmware, the status light is flashing in red and green; If the terminal is not login or required to login, the status light is flashing in red.

If the terminal logined server and in free status, the status light is normal green on; If the terminal logined server and is executing the task, the status light is flashing in green.

⑨ The power interface: connect 24V power DC power supply.

⑩ ANT: antenna interface

Introduction

Packing list

Network audio terminal is including the following accessories, please check it before installation, please contact the supplier if any missing.

(1). Network audio terminal 1pcs

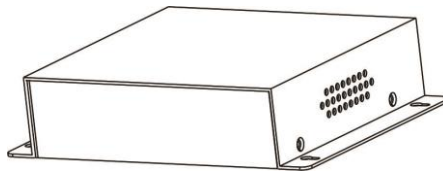

(2).DC24V/1A Power adapter (for 20W terminal only) 1pcs

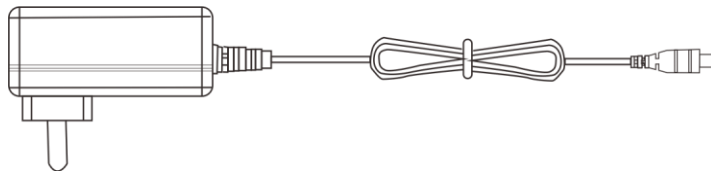

(3). DC24V/2.7A Power adapter (for 60W terminal only) 1pcs

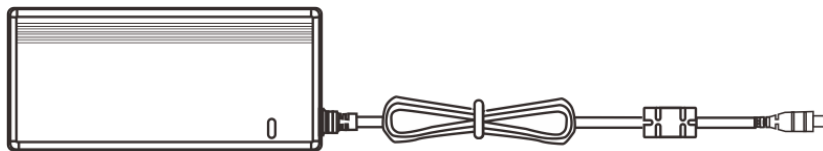

(4). Cup head tapping screw (M4*25) 4pcs

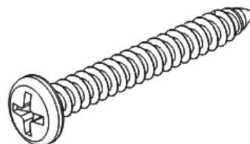

(5). Plastic swelling cover (F7) 4pcs

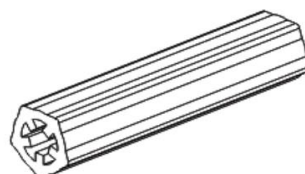

(6).Detachable terminal (3.81-4P) 2pcs

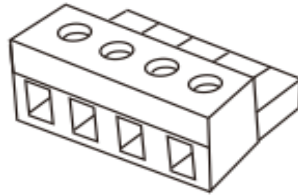

(7). Antenna 1pcs (for 2.4G wireless module terminal only)



(8). Installation manual 1pcs

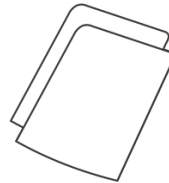

(9) Certification 1pcs



Wiring

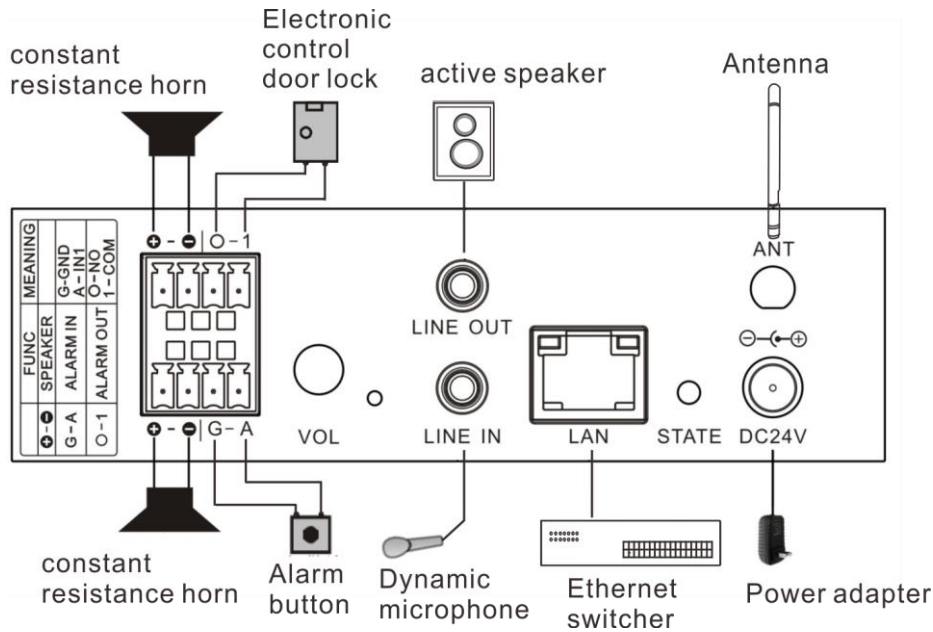

- (1) + - Amplifier output port, it can connect with the constant resistance loudspeaker, constant resistance horn ...etc.
- (2) A-G alarm input interface, it can connect with the alarm button or other signal.
- (3) O-1 alarm output interface, it can connect with electrical door lock.
- (4) Line input interface can connect with dynamic microphone, computer, DVD ...etc.
- (5) Line output interface can connect with active loudspeaker, audio power amplifier ...etc.
- (6) Terminal "LAN" interface can connect with switcher network output port.
- (7) Connect the power adapter one end to the Network audio terminal DC24 port, and the another end connect to the power plug.

Note:

- 1、Two loudspeakers power should be same.

2、20W series Network audio terminal should connect with two 10W loudspeakers, 60W series terminal connect with two 30W loudspeakers.

Basic Network Setting

Connect the cable and power on as per the installation manual, then revise the terminal network parameters according to the live environment.

There have below two methods:

Terminal Equipment Scanning Tools

(1) From [CD: \ tools \] directory to find and run "IP configuration tool" audio terminal, after start it , please enter the default password "123456".

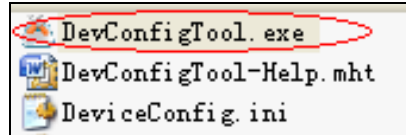

(2) From the right menu choose **【Mandatory configuration】** , then fill the correct parameters in the **【terminal parameters】** , click "send parameters" button to complete the IP parameters Settings.

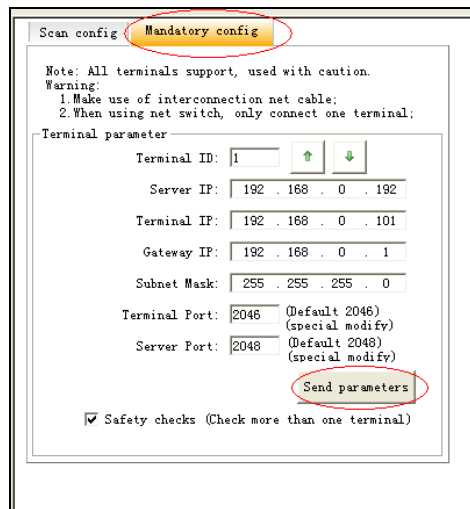

Note:

- 1、 Please use the administrator mode to run and close the firewall or other related software when using the Windows 7 operating system;
- 2、 Terminal equipment scanning tools can only configure one terminal at one time. Please make sure that a computer only connect one target terminal when using this method.

Web page Mode

Enter into the Network audio terminal web interface and revise the terminal parameters according to the environment, click "save" after setting completed.

Please refer to the user-define terminal parameters setting for more details.

User-define terminal parameters

Login Web Interface

(1)Please input the Network audio terminal IP address in the browser (the factory default IP address is 192.168.1.101), it will auto-play the IP address when the press the force button), then enter.

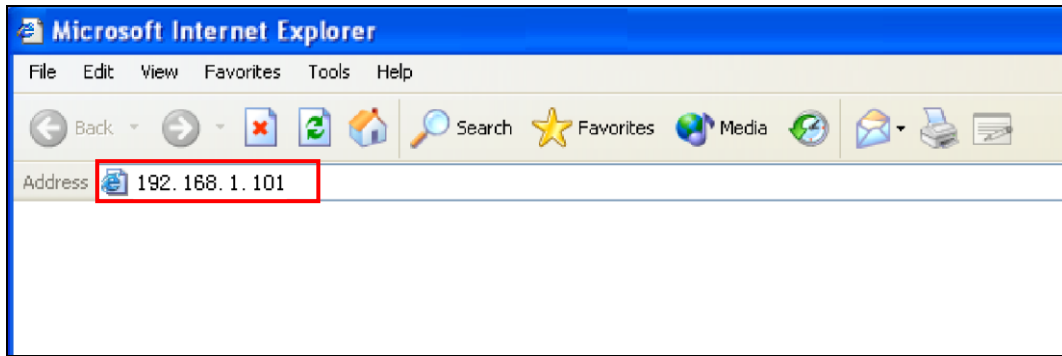

(2) Enter the user name and password in the web page (the default user name and password is admin)



(3) Click OK to enter terminal web page.

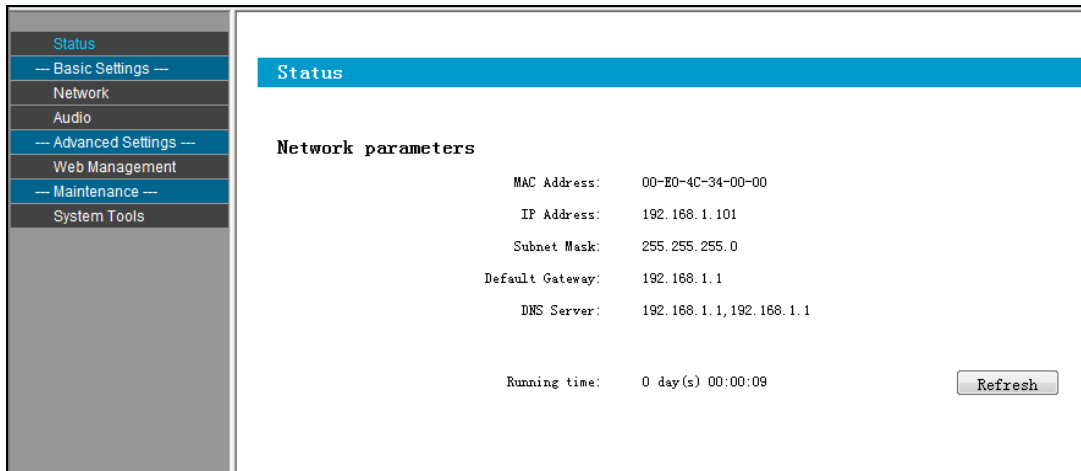

Network Parameters

Click "network parameters" from the basic settings enter into the network parameters modification interface, it can modify the following network parameters, select the auto update, if started the version server, the terminal can automatically detect the current firmware whether it's latest version or not during login the server, if it's not the latest version, then it will update to the latest version automatically.

Device NO.	The only No. to identify host, it can't repeat with other device or hosts, defaults device number is 1.
Terminal IP	Terminal IP address and port Note: It can't revise except with the special situation (The default is 2046)
Subnet mask	The subnet mask of the terminal
Default gateway	The network gateway of the terminal
Preferred DNS server	The preferred domain name interpreter IP of terminal
Alternate DNS server	The standby domain name interpreter IP of terminal
Version server	Version server IP, terminal can connect the version server and auto-upgrade program when it's restarting(select the auto-upgrade option)
System server	IP PA server IP address

The wireless channel setting (2.4G wireless module is available)

Enter into network parameters page and adjust wireless channel to a free channel (1-32 channel).

Language setting

You can switch Web language between Chinese and English, it will be workable after restarting the web page.

Audio parameters

Enter "Audio parameters" of "Basic setting" can set audio coding format, volume and sample rate...etc.

Coding mode	Intercom or broadcasting coding, PCM means uncompressed data, ADPCM means compressed data(small network data)
Line input volume	The line input volume
Line input sound source	Terminal input sound resource (microphone, line input)
Intercom sampling rate	The terminal talking sampling frequency (8000 Hz, 22050 Hz)
Talk output volume	The terminal output total volume within the conversation(0~15, 6 grade is 5dB)
Broadcast sampling rate	The terminal broadcasting sampling frequency (8000 Hz, 22050 Hz)
Broadcast output volume	The terminal output total volume within the broadcasting(0~15, 6 grade is 5dB)
Audio priority	It can select local and network priority, the default is network priority. Network priority: network broadcasting>PTT broadcasting>line input; Local priority: line input>network broadcasting>PTT broadcasting

Audio auto-detect function

In order to avoid line noise and sound resource noise output from the loudspeaker, when line input audio range less than a specific value (Line input threshold), the amplifier will be closed with 1 min. Line input thresholds can be set from audio parameters in web page, grade one is lowest audio range and the highest is grade five.

Wireless amplification sampling rate (2.4G wireless module is available)

It can select different wireless amplification sampling rate in Web page audio parameters, select the far distance can acquire further transmission distance, select high quality can acquire higher tone quality, the distance is relatively shorter.

Password Setting

You can revise the web page logging account and password in the WEB management parameters.

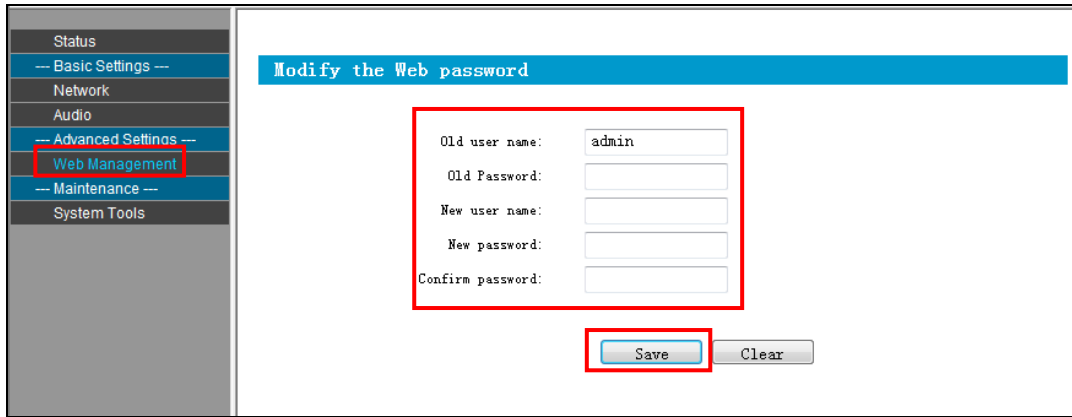

Reboot Device



Note: All the parameters modification in web page will be effective after restart the device.

Reset to defaults

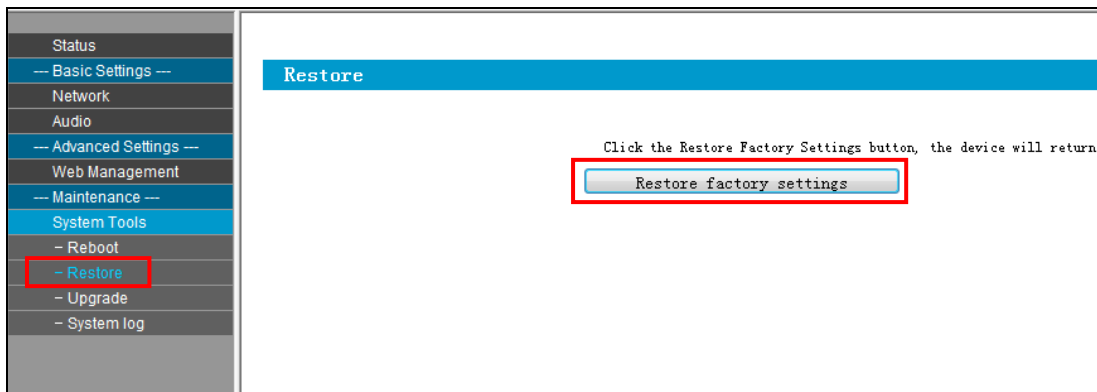

Reset to defaults: all the parameters reset to the defaults.

Update Firmware (Note: It shouldn't update unless there is a special requirements)

Visit the terminal Web pages from Web browser, click the "device maintenance" -> "system tools" -> "firmware upgrade", click "enter the firmware upgrade mode" button to enter the firmware update WEB page ,then choose the factory offered firmware update file , click "firmware upgrade" button to upgrade.

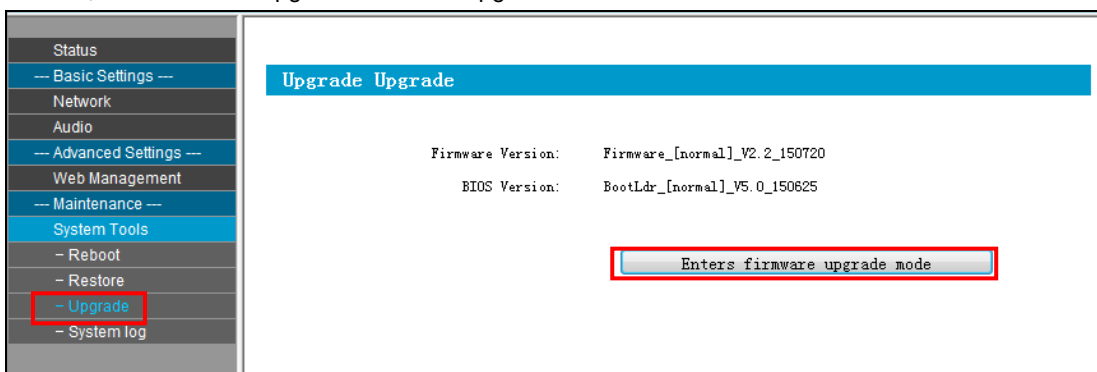

Basic Function

Offline broadcasting

Network audio terminal can receive the offline broadcasting which is initiated by other terminals.

Real-time broadcasting

Open the server software, select the target zone in "target area" terminal choice box; Open WAV or MP3 format audio documents, click "start broadcasting" button, terminal loudspeaker will output the audio documents when server software in broadcasting.

Remark: please refer to the server software manual for specific operation.

Receive terminal broadcasting, server task

Under server authorization:

Terminal can receive server Wav、MP3 format timing program, timing broadcasting, timing ringing, document broadcasting, fire alarm...etc, it also can receive the broadcasting from other terminals.

Remark: The broadcasting output volume can be set from Web page audio parameters.

Fault Exclude

Why the terminal cannot login the server?

1.Check the software server and the main controller is normal opened or not. It's required to close all firewall before open the software server (including system built-in firewall and other antivirus software firewall) .

2.Check the network connection is normal or not. After the terminal powered on, the network port green light is norm on, meantime the orange light will be short and fast flash, it means the network cable hard-connected normal. If the network port green light is not on, it means the network hard-connected problem, please check the terminal network cable and switcher whether they work normal, damaged and disconnect or not etc.

3.Check the terminal IP setting. Please check the terminal ID, sever IP, local IP, gateway IP ...etc parameters.

Why it appears "terminal network services (UDP) start fail" warning within the process of start server software?

Appearing this warning information, it's usually the local network connection has been disconnected, please connect the local network cable well and exit the software, then restart it.

Why web show abnormal?

Please clear the caches or change the browser.

How to change the web login account and password?

- 1 .Click the password setting in webpage .
2. Input the old account and old pass word.
3. Input the new account and new pass word.
4. Input the new password again for confirmation
- 5.Click save .

The new account and new password will be effective after reboot.

Copyright Announcement

Copyright

The copyright is reserved of the SPON Communication Technology Co., LTD (abbreviation SPON), if without the permission of the company in written form, any company and personage shall not arbitrarily excerpt, copy mentioned file information, and shall not spread in any forms.

According to the legal provisions, copy including translate to other language or switch to other format. Mentioned document spreading in network media, SPON allow download and print for personal uses. Any parts of the document can not be modified and for commercial uses. If any damage and losses which is caused by illegality modify and switch the document, SOPN shall not take any responsibility.

Guarantee

Regarding to the information of the mentioned handbook, if any modify, kindly understand that there is no any notice.

The handbook shall provide the correct indication, information and suggestion, and not guarantee to any indicated and implied information. User should take the responsibility of the products applying.

SOPN shall not making any guarantee for the handbook, including but not only for the guarantee of implied marketability and specific purpose. Also SPON shall not take any responsibility, if any indirect or incidental losses caused by mistaken use of the handbook.



Wechat

SPON Communication Technology Co., Ltd.
www.spon.com.cn
Service Hotline: 400-823-2588
Reserve the amendment right without notice

